

GALFRE

COSTRUZIONI MACCHINE AGRICOLE

**ROTARY DRUM MOWING MACHINES
AND CONDITIONING - MOWERS**

FR/G 130 – FR/G 170 – FR/G 190 – FR/G 210

FR/G 170/C – FR/G 190/C – FR/G 210/C



Via Centallo, 136 - 12044 ROATA CHIUSANI - CENTALLO (CN) - ITALIA

Tel. 0171.718005 Fax 0171.718004 Internet: www.galfre.net E-mail: info@galfre.net

“Contains Declaration of Conformity” (EC)

📖 Read this Manual thoroughly before operating the machine 📖

DICHIARAZIONE DI CONFORMITÀ

The logo for Galfrè, featuring the brand name in a stylized, bold, white font on a red rectangular background.

The manufacturer **Galfrè Domenico & C. s.n.c.**

Via Centallo, 136 - ROATA CHIUSANI - 12044 CENTALLO (CN) Italy

Tel 0171.718005 Fax 0171.718004

declares under its responsibility that the machine:

ROTARY DRUM MOWING MACHINE

Model

Serial number n.

Year

fully complies with Essential Requisites for Safety and for Safeguarding health set out in:

98/37/CE (Che abroga e comprende le Direttive 89/392/CEE, 91/368/CEE, 93/44/CEE e 93/68/CEE)

With the aim of verify the conformity towards those directives, we consult the harmonized standard:

EN 745 *1999*

EN 1553 *2001*

and technique specific:

ISO 11684 *1995*

Centallo (CN), _____

The legal administrator

TABLE OF CONTENTS

1	INTRODUCTION	4
2	GENERAL INFORMATION	5
2.1	INFORMATION ON THE MANUAL	5
2.2	INFORMATION ON THE MACHINE	6
2.2.1	Identification of the machine	7
2.2.2	Conforming use	8
2.2.3	Adverse field conditions	9
2.3	FEATURES OF THE MACHINE	10
2.3.1	Identification of the models	10
2.3.2	Main components	11
2.4	OPERATION AND TECHNICAL FEATURES	12
2.5	NOISE LEVEL	15
2.6	PACKING, TRANSPORT AND LIFTING	16
2.7	STORAGE	18
2.8	DISPOSAL AND SCRAPPING	18
3	SAFETY RULES	19
3.1	SAFETY AND ACCIDENT PREVENTION RULES	20
	ATTENTION!	23
	ATTENTION!	23
3.2	SAFETY SIGNS WITH WARNING SYMBOLS	25
3.3	LOCATION OF SAFETY SIGNS ON THE MACHINE	28
4	INSTALLATION AND OPERATION	29
4.1	SAFETY RULES FOR ATTACHING TO THE TRACTOR	29
4.2	CHECK LIFTING AND STABLE OPERATION OF THE TRACTOR	30
4.3	TRANSPORT ON PUBLIC ROADS	31
4.4	ATTACHING TO THE THREE POINT LINKAGE OF THE MACHINE	34
4.4.1	Assembly of the drive shaft	36
	Overrunning clutch drive shaft	37
4.4.2	Hydraulic system	38
4.5	ADJUSTEMENTS	39
5	OPERATING INSTRUCTIONS	41
5.1	SAFETY RELEASE DEVICE	44
6	MAINTENANCE	45
6.1	LUBRICATION OF MECHANICAL COMPONENTS	46
6.2	LUBRICATION	47
6.2.1	Lubrication of the centre gearbox	47
6.2.2	Lubrication of overgear unit	48
6.2.3	Lubrication of conditioner reduction gearbox	48
6.3	KNIVES	49
6.4	CURTAIN REPLACEMENT	50
6.5	FURTHER TROUBLESHOOTING	51
7	GUARANTEE	52
8	SPARE PARTS	54

1 INTRODUCTION

The manual and the attached declaration of conformity shall be considered part of the machine until its disposal and have to be passed on to new operators or owners.

If the manual is not supplied together with the machine or if it becomes lost it is recommended to order a copy from GALFRÈ snc.

Thoroughly read the use and maintenance manual and follow the instructions noted on it before using, checking and operating the machine.

If for any reason you do not understand any part of this manual, including tables or drawings, contact GALFRÈ snc and request assistance from the service department.

GALFRÈ snc is at full disposal of users, sales staff and any other person in order to improve understanding of the whole manual.

In conformity with existing law instructions on hazardous situations are indicated as described in chapter 3.

This Manual has been written in conformity with the rules current at the time of printing.

The Manual is part of the machine and has to be passed on to new operators or owners together with the Declaration of Conformity.

April 2005

2 GENERAL INFORMATION

2.1 INFORMATION ON THE MANUAL

This operator's manual is designed to help familiarise you with operation and maintenance of the machine. Performance and life of the machine depend upon proper maintenance and safe operating practices.

Some pictures may be different from your machine or show some components removed for purposes of clarity.

The manual and the items dealt with in it are in compliance with the "Directive 98/37/EC".

The mower comes equipped with safety labels in place. In conformity with the existing Community law keep all safety labels legible and replace them if necessary.

The manual is designed for authorised professional operators, who are appropriately trained and familiar with the tractor to which the mower is attached.

Technical information contained in the manual is intellectual property of the company GALFRÈ snc and shall be kept confidential.



The symbol on your left together with the signal words:

DANGER!
ATTENTION!
WARNING!

is used to call attention to safety precautions which should be followed by the operator. Follow the recommendations.

It is recommended to use originally manufactured spare parts and accessories.

The guarantee shall not apply if not originally manufactured spare parts are used. The use of non genuine parts could affect life and performance of the machine.

2.2 INFORMATION ON THE MACHINE

The materials used for building GALFRÈ snc mowers have been chosen according to the tasks for which the machine has been designed and built: any non-conforming use can cause damages to persons and property and affect the operation of the machine.

Conforming use of the mower also specifically includes compliance with operating, repair and maintenance instructions contained in this manual.

GALFRÈ snc is in no event liable for non-conforming use of the machine.

GALFRÈ snc is not liable for any damages and injuries, including severe injuries, to operator and other people or property resulting from any unauthorised changes or modifications to the machine.

Proper operation of the machine and compliance with the instructions contained in the manual and safety precautions will reduce the risk of accidents and injuries and ensure higher performance, while extending machine life and reducing the risk of troubles to the lowest level.

GALFRÈ snc shall in no event be liable for failure to comply with the safety instructions given in the manual.

2.2.1 IDENTIFICATION OF THE MACHINE

The machine identification plate, located on the frame, bears the EC mark, the Manufacturer's data, the model, the serial number, the year of manufacturing and the mass of the machine.



Location of EC plate on the machine:



When ordering spare parts always use the model number, frame number and year of manufacturing.

2.2.2 CONFORMING USE

ROTARY DRUM MOWING MACHINES and CONDITIONING - MOWERS have been designed and built for use in agriculture for mowing grass, pasture and permanent grasslands, alfalfa and other kinds of fodder crop.

Models equipped with CONDITIONER crush or split (depending on the conditioner) newly cut forage stems, accelerating the drying process and reducing the time it stays on the field.

The machine has been designed for professional users and shall be operated exclusively by authorised trained staff holding driving licence.

The machine is not designed for operation in other fields than agriculture.



ATTENTION!

The machine is for use by one operator at a time. The use of the machine for a purpose for which it is not designed than the intended one is considered as non-conforming use.

GALFRÈ snc is not liable if **safety labels** are missing, illegible or if they have been removed from their location (see par. 3.2 e 3.3).

If safety labels are damaged or missing, order new labels. Refer to the information contained on the machine identification plate.

This machine has been designed for use during the day. At night or under conditions of reduced visibility use the machine light devices.

GALFRÈ is in no event liable for any damages and injuries, including severe injuries, to operator or other people and property resulting from any unauthorised changes and modifications to the machine.

2.2.3 ADVERSE FIELD CONDITIONS

This section illustrates the main adverse field conditions when using the MOWER:

- Make sure that there are not any stones or rocks on the ground (diameter over 8-12 cm);
- Make sure that there are not any stumps higher than 10 cm and diameter over 8-12 cm;
- Make sure that there are not any metal elements on the ground, such as nets, cables, ropes, chains, pipes etc;
- Follow recommendations for height adjustment and make sure that no one is within 50 m of the mower;
- It is recommended not to work with the machine fully lowered to the ground in wet grass conditions to avoid damaging crop and affecting performance of the machine.

2.3 FEATURES OF THE MACHINE

2.3.1. IDENTIFICATION OF THE MODELS

GALFRÈ rotary drum mowing machines and conditioning - mowers are available in three different models in order to meet customers' specific needs:

FR/G 130 - FR/G 170 - FR/G 190 - FR/G 210

FR/G 170/C - FR/G 190/C - FR/G 210/C

"**FR/G**" is the abbreviation for the type of machine Rotary Drum Mower.

The number indicates the machine's cutting width (cm).

"**C**" indicates that the machine is equipped with a conditioner (roller conditioner or arrow element conditioner).



mod. FR/G 130



mod. FR/G 190



mod. FR/G 210/C

2.3.2 MAIN COMPONENTS

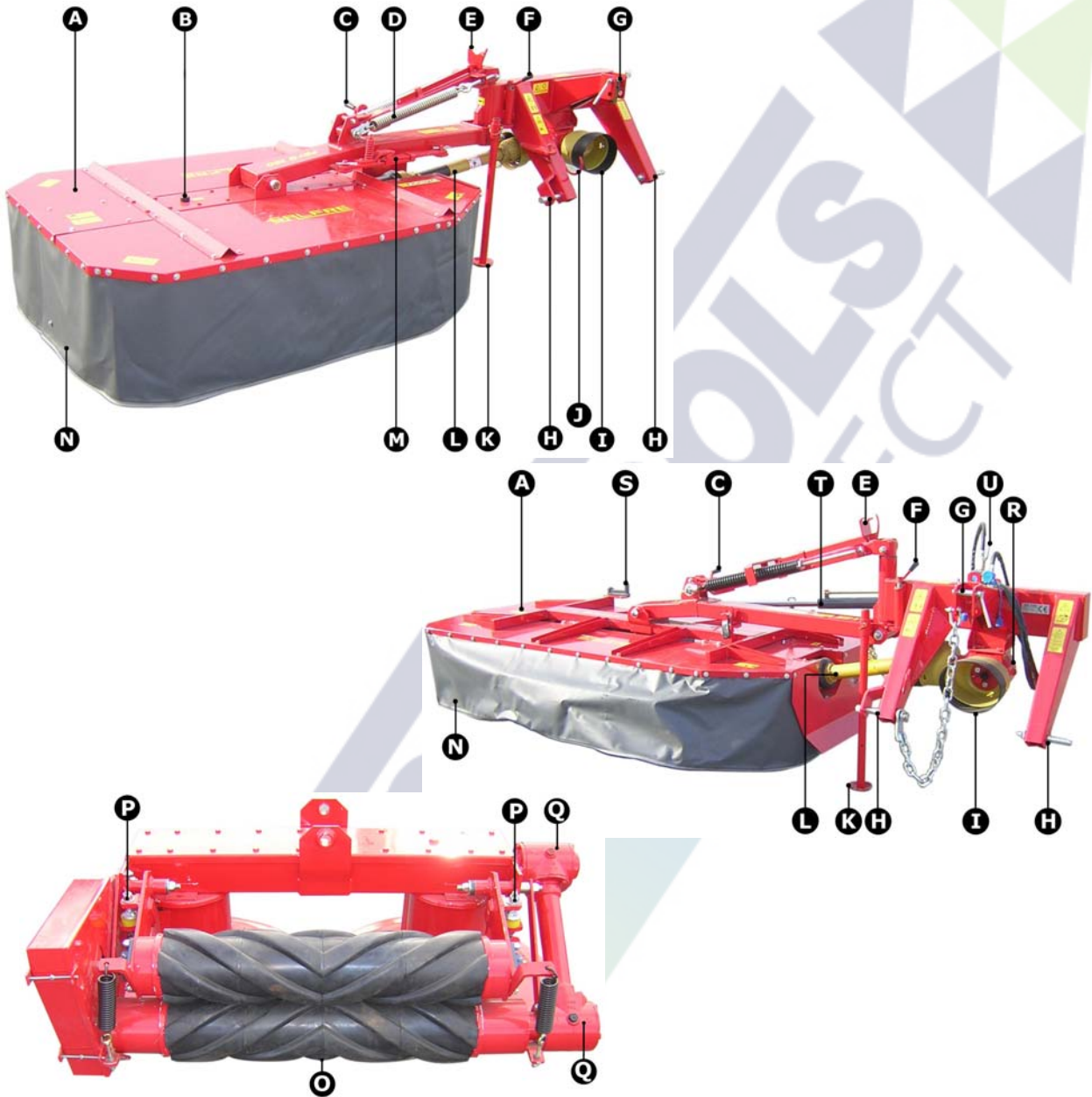

- | | |
|--|---|
| <ul style="list-style-type: none"> A. Hoods B. Lubrication box C. Mowing unit locking lever D. Cutting unit shock absorber E. Pry bar for knives replacement F. Three point linkage safety pin G. "Three point linkage" H. Lift arms couplings I. Inner cover J. Support leg (drive shaft) K. Stand | <ul style="list-style-type: none"> L. Overrunning clutch drive shaft M. Safety release bar N. Curtain O. Conditioner rollers P. Roller adjustment Q. Conditioner reduction gearbox R. Overgear unit S. Windrower adjustment lever T. Hydraulic cylinder U. Hydraulic locking device |
|--|---|

2.4 OPERATION AND TECHNICAL FEATURES

The machines are drawn by the tractor by means of the three point linkage. The machines are equipped with rotary cutter-holder discs of oval shape operated by the power takeoff of the tractor.

The mowing unit consists of a cutter bar to which quick rotating knives are attached. The product is cut as a result of the knives action in the lower part of the stem.

Drums have support rotary plates at their bottom.



Drum mowing unit

The articulated point at the centre of the drums permits perfect adaptability to all ground conditions, also preventing the squashing of the sward, even in the event of working conditions over very sloping ground.

All machines are equipped with a safety release device. If an obstacle is hit, the safety release device allows the cutter bar to swing back, thus reducing significantly the risk of damages to the machine (see par. 5.1).

All gearings are encased in oil bath box.

CONDITIONING MOWERS considerably reduce the hay making times therefore considerably reducing bad weather risks, whilst also ensuring excellent product conservation conditions.

The GALFRÈ CONDITIONING MACHINE is available in two versions:

- Helical roller conditioner;
- Arrow element conditioner.

The **Helycal rubberised roller conditioner** is particularly suitable for the treatment of alfalfa, clover and leguminous plants.

The roller rib intersection is regular, and the rotation system convergence ensures excellent product treatment (through squashing) in such a way that the drying speed of the stems is the same as that of the leaves.

The forage dries faster and more evenly, the product being deposited in the form of soft windrows.

The treatment intensity can be regulated by two springs positioned on the external part of the two rollers (see par. 4.5).



Helycal rubberised roller conditioner

The **arrow element conditioner** is particularly suitable for the treatment of weeds.

The forage is pushed into the conditioner, where it comes into contact with the V-shaped rotor prongs.

The grass is made to pass through it and then brushed against the sheet guard element where the treatment takes place.

The forage, passing through the arrow elements, is abraded and dropped in fluffy windrows.

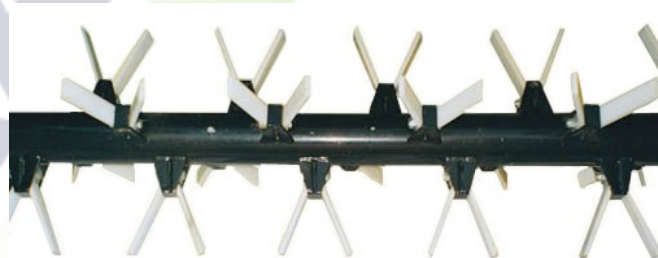

Arrow element conditioner

DRUM MOWERS are available in two different versions: FR/G (without conditioner and in 4 models) and FR/G/C (with conditioner and in 3 models).

<i>Rotary drum mowers</i>		FR/G 130	FR/G 170	FR/G 190	FR/G 210
Required power	HP/KW	20/15	40/30	60/44	60/44
Max. PTO revolutions	r.p.m	540	540	540	540
Cutting width	m	1,30	1,65	1,85	2,10
Drums	n	2	2	2	4
Knives	n	6	8	8	12
Weight	kg	230	460	520	700
Max. drum speed	r.p.m	2100	1890	1650	2100
Width of the machine	m	1,35	1,35	1,45	1,85
Length of the machine	m	2,85	3,40	3,50	3,85
Height of the machine	m	1,03	1,20	1,20	1,35
Height in transport position	m	2,45	3,10	3,20	3,50

<i>Rotary drum conditioning mowers</i>		FR/G 170/C	FR/G 190/C	FR/G 210/C
Required power	HP/KW	70/51	80/59	90/66
Max. PTO revolutions	r.p.m	540	540	540
Cutting width	m	1,65	1,85	2,10
Drums	n	2	2	4
Knives	n	8	8	12
Weight with roller conditioner	kg	610	680	900
Weight with arrow element condit.	kg	--	--	800
Max. drum speed	r.p.m	1890	1650	2100
Max roller condit. speed	g/min	945	945	945
Width of the machine	m	1,35	1,45	1,85
Length of the machine	m	3,40	3,50	3,85
Height of the machine	m	1,20	1,20	1,35
Height in transport position	m	3,10	3,20	3,50

2.5 NOISE LEVEL

Noise level tests are carried out on all machines manufactured by GALFRÈ snc in cooperation with IMAMOTER, CNR Turin.

According to tests, even by changing the position of the machine the noise level is lower than 90,0 dB(A).

On the basis of the noise level it is recommended to wear suitable hearing protection.



WARNING!

Cleaning, regular maintenance of the machine and systematic lubrication help reducing the noise produced by the machine.

The resulting noise level depends not only on the noise caused by the machine but also on other factors such as the working area and exposition to loud noise.

Nevertheless the information on the noise caused by the machine will be useful to the employee or the user in terms of risk analysis.

2.6 PACKING, TRANSPORT AND LIFTING

The machine can be delivered ready-to-use or with some parts to be assembled.

If it is delivered with packing, mount the hoods on the mowing unit.

Lock the plates (A) on the transmission gear box with 4 bolts (see arrows).

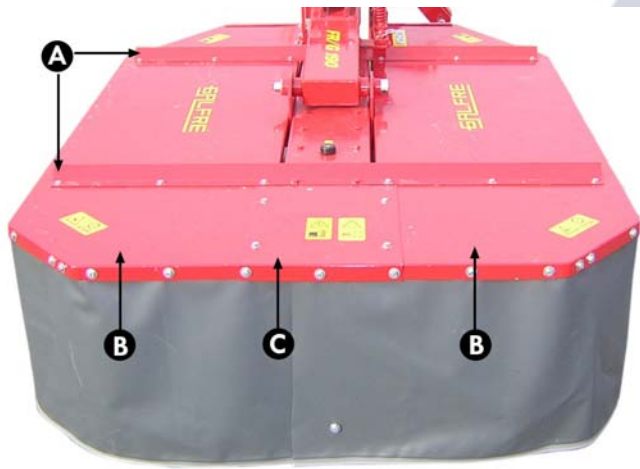

Then mount the two hoods (B) and protectors (C) and (D).



Machines include a sticker kit to be placed on the hoods, as well as bolts and fastening nuts needed to install the protectors. For safety labels correct placement on the machine see par. 3.2 and par. 3.3.

Hoods are generally provided with protective curtains. In case assembling is needed, follow instructions in par. 6.4.

When the machine is not attached to the tractor, it can be raised by means of a crane, using the pull eye bolt as shown in the label attached to the machine.

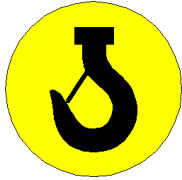

For raising the machine use safety hooks and suitable cables to be mounted as indicated by labels.

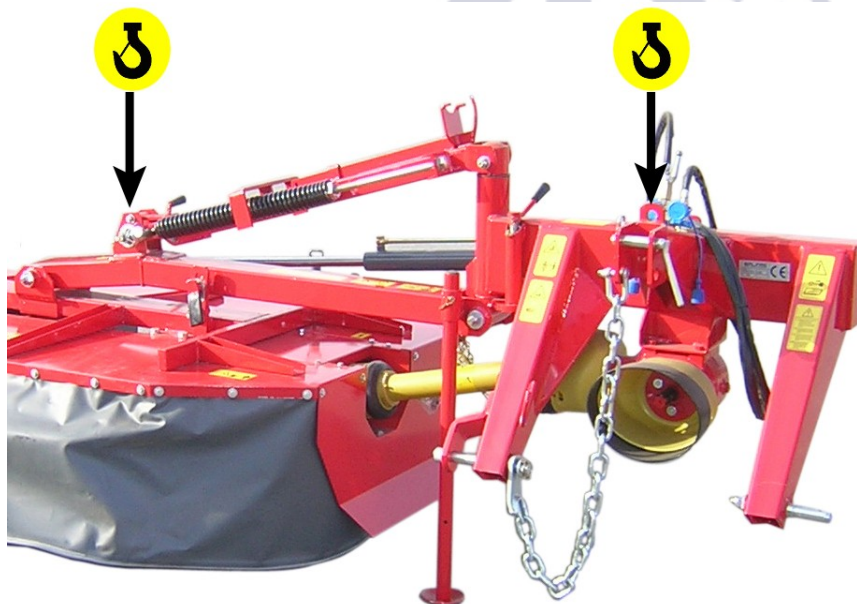

Lifting hooks

Lifting of the machine shall be performed by skilled staff.



ATTENTION!

Before lifting make sure that the three point linkage bolt is properly hooked (see par. 4.3 and 5).

2.7 STORAGE

If the machine is not used for a long period it is necessary to store it inside to avoid exposure to weather and dust. Before operating it again, it is good practice to clean the machine and lubricate all mechanical components to prevent rust.

- Clean the machine thoroughly;
- Inspect the machine for damaged parts and scratched paint;
- Make sure that safety signs are legible and located properly on the machine. Replace damaged safety labels (see par. 3.2 and 3.3);
- Replace damaged or worn curtain (see par. 6.4);
- Lubricate all mechanical components, locking pins, the coupling head to the cardan joint (see par. 6.1);
- Replace oil in the gearbox and in the cutter bar following the instructions (see par. 6.2);
- If possible, store the machine in an enclosed place.

2.8 DISPOSAL AND SCRAPPING

The machine shall be scrapped in suitable dumps in compliance with the existing law.

Collect used oil and dispose it according state and local regulations.

Used oil is harmful according to the existing law, therefore it shall be properly collected. Contact the Oil Collection Centre. (In Italy - C.O.O.U. – Consorzio Obbligatorio Oli Usati (Free number 800 863 048).

Collect properly plastics, aluminium and steel components for them to be recycled.

FOLLOWING SAFETY RULES ARE SERIOUS FOR YOUR SAFETY AND THE SAFETY OF OTHERS: READ THEM THOROUGHLY AND FOLLOW WITHOUT EXCEPTION.

3. SAFETY RULES

When operating, checking or doing maintenance, follow the existing safety rules.

Failure to follow basic safety rules can result in accident or injury during operation, maintenance and repairing of the machine.

GALFRÈ MOWERS have been exclusively designed and built for mowing grass, pasture and permanent grasslands. The use of the mower for another purpose than this shall be authorised in writing by the manufacturer.

The Manufacturer is not liable for any changes and modification made to the machine without his prior approval (in writing).



ATTENTION!

GALFRÈ is not liable for any damages resulting from misuse or use for a purpose for which the machine has not been designed.

The machine shall be operated exclusively by authorised trained staff which is familiar with the operation of the machine and aware of the related hazards.

For further assistance contact the service department of the Company.

Observe following safety instructions carefully.

3.1 SAFETY AND ACCIDENT PREVENTION RULES

The safety rules described in the manual refer exclusively to the purpose for which the machine has been designed and built. In addition to the recommendations contained in the manual hazard control and accident prevention depend upon the awareness, concern, prudence and proper training of personnel.



WARNING!

Before operating the machine, inspect carefully all parts.

- In addition to the instructions described in the manual follow all general safety and accident prevention rules. Before operating the machine or performing maintenance read and understand the instructions.
- The labels affixed to the machine call attention to safety precautions that shall be followed.
- Make sure that safety labels are legible. Clean and replace them if necessary.



ATTENTION!

Before maintenance, adjustment or cleaning, lower the machine to the ground, turn off the engine of the tractor, disengage power takeoff, set hand brake and remove the ignition key.

- Before operating the machine make sure that all guards and safety devices are properly secured and in good conditions; replace damaged safety devices. In particular **check wear on guards, curtain and connecting devices before operating the machine.**



DANGER!

For your safety and the safety of others do not tamper with, damage or remove safety devices.



ATTENTION!

While working make sure that no people or animals are within 50 m of the machine. When working near public roads or public places keep others away and be more careful.

- Keep the manual handy to check operational running. If the manual becomes lost or damaged, order a copy from GALFRÈ.
- **The machine shall be operated exclusively by authorised trained staff.**
- **The machine has been designed to be operated by one operator at a time.**
- Never operate the machine if you feel tired, if you are sick or if you have drunk alcohol or taken drugs or medicines.
- The operator shall wear clothing and equipment appropriate for the job to avoid entanglement with parts (no loose fitting clothing, belts, necklaces, bracelets, rings).



During operation, maintenance, repairing, driving or storing of the machine, the operator shall wear safety shoes, safety gloves, and, if necessary, earplugs, dust mask and safety glasses.

- There might be some dust production during operation. It is recommended to use tractors equipped with cabins with filters on the fan system or to use suitable fan devices such as masks in order to protect the breathing system.
- Before operating the machine check wear on cutting devices (knives and drums). **Replace worn or damaged knives and knife holders.** After replacing make sure that all fasteners (bolts, screws and nuts) are of the type recommended by the Manufacturer.
- If an object is hit, damaged or worn knives are more likely to be thrown out of the machine. Replace them immediately (see par. 6.3).
- After transport perform an inspection. If the machine has been damaged contact GALFRÈ.
- Make sure that there are not any foreign bodies in the machine (debris, tools, etc.) which could affect operation or cause injuries to the operator.
- If using compressed air or water for cleaning, wear safety glasses and masks and keep others away.



DANGER!

Do not get on the machine or allows riders while the machine is in operation.

- After hitching make sure that the drive shaft is installed properly.



ATTENTION! DANGER!

Make sure that the drive shaft guards are in good conditions.

- Replace worn or damaged drive shaft guards.
- When the machine is not connected to the power takeoff, the hydraulic hoses and the drive shaft shall be properly secured to their support elements.

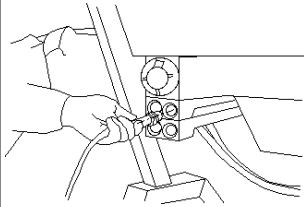

Make sure that hydraulic hoses are properly installed.

Check hydraulic hoses for wear and replace them if necessary (anyway at least every 6 years).

- Detach the machine on level ground, with the cutter bar lowered to the ground, with the aid of the stand. Make sure that the machine is level.
- Before performing maintenance under raised parts of the machine secure them using suitable blocks.



ATTENTION!

Never stand between the tractor and the mower when the engine is running and the power takeoff is engaged.



ATTENTION!

Make sure that the drums have stopped before approaching the machine.



WARNING!

The operator shall only perform maintenance as recommended in the manual.

- Any changes and modifications to the machine could cause injury or accident for which the operator only shall be held liable.

**DANGER!**

Pinching and crushing hazard when bringing the machine to the transport and working position. Operate with the machine more carefully and keep others away from the area.

Use exclusively originally GALFRÈ manufactured spare parts.

GALFRÈ shall not be held liable under the following circumstances:

- If the MOWER has been misused or operated by unauthorised or unskilled staff;
- Maintenance failure;
- Unauthorised changes or modifications to the machine;
- If not originally manufactured or not suitable spare parts have been used;
- Failure to follow, even partly, the instructions;
- Failure to comply with the general safety rules at work;
- Facts beyond its reasonable control.

3.2 SAFETY SIGNS WITH WARNING SYMBOLS

Following symbols are intended to alert the operator to a potentially hazardous situation and call attention to safety precautions.

Safety labels affixed to the machine indicate the existence of hazard and safety precautions that shall be followed.

SYMBOL	DESCRIPTION
	<p>1. ATTENTION ! Thoroughly read the operator's manual before operating the machine. Follow the instructions and the safety rules during operation.</p>
	<p>2. ATTENTION! Before maintenance and adjustment, read the operator's and maintenance manual, stop engine and remove the ignition key.</p>
	<p>3. ATTENTION! – High pressure fluid hazard. Refer to the manual before taking any action and seek medical assistance in the event of contact with dangerous fluids. (hydraulic system models only)</p>
	<p>4. ATTENTION! Check the direction of rotation and the revolutions (540 r.p.m.) of the takeoff power of the tractor before assembling the drive shaft.</p>
	<p>5. ATTENTION! – DANGER Wait for all drums of the mower to stop before approaching the machine.</p>



1. ATTENTION ! Thoroughly read the operator's manual before operating the machine. Follow the instructions and the safety rules during operation.



2. ATTENTION! Before maintenance and adjustment, read the operator's and maintenance manual, stop engine and remove the ignition key.



3. ATTENTION! – High pressure fluid hazard. Refer to the manual before taking any action and seek medical assistance in the event of contact with dangerous fluids. (hydraulic system models only)



4. ATTENTION! Check the direction of rotation and the revolutions (540 r.p.m.) of the takeoff power of the tractor before assembling the drive shaft.



5. ATTENTION! – DANGER Wait for all drums of the mower to stop before approaching the machine.



6. ATTENTION! – DANGER Rotating knives. Keep hands and feet away from moving parts.



7. ATTENTION! Thrown object hazard, **do not approach the machine.** Keep a safe distance of at least 50 meters from the machine.



8. ATTENTION! Do not get on the machine and never allow riders.



9. ATTENTION! – Entanglement hazard. Keep hands away from the running drive shaft.



10. ATTENTION! - Crushing hazard. Never stand between the tractor and the machine.



11. DANGER Crushing and shearing hazard. Keep hands away and stand clear. Keep a safe distance.



12. ATTENTION! – Crashing and crushing hazard, keep away from the danger zone when switching mower from transport mode to field mode and vice versa.



13. ATTENTION! – Injury hazard. Keep the distance, keep hands away from conditioner rotors.
(models equipped with rotor conditioner only)



13. ATTENZIONE! – Trapping hazard. Keep hands away from rollers when conditioner is on. Keep the distance.
(models equipped with roller conditioner only)



14. ATTENTION! Hook the machine at the indicated points for raising.



15. Wear proper protective equipment.

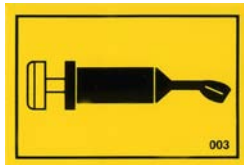

16. Lubrication points (see par. 6.1).



17. Reduction gear oil tank (see par. 6.2).



18. Three point linkage locking device (see par. 4.3 and 5).

3.3 LOCATION OF SAFETY SIGNS ON THE MACHINE

This section illustrates the location of safety signs on the machine.



ATTENTION!

Make sure that safety labels are legible. Clean them with soapy water and a cloth.

Replace damaged labels.

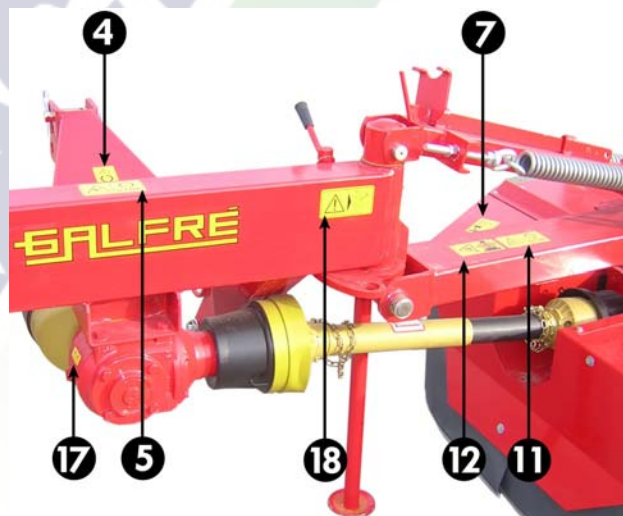
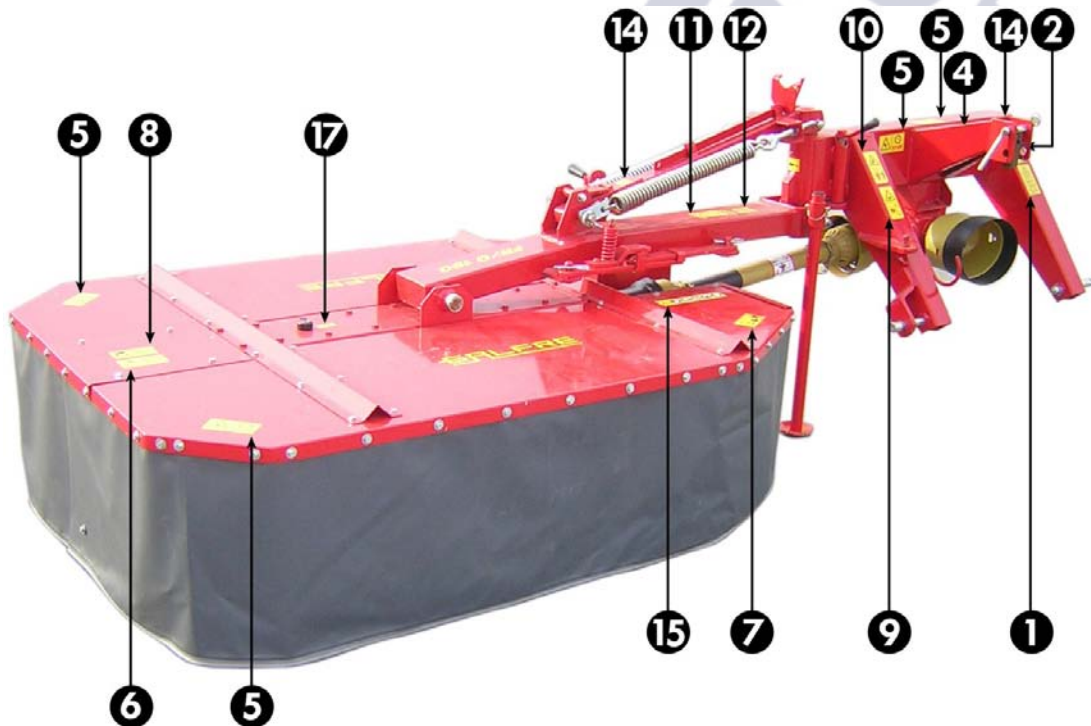

4 INSTALLATION AND OPERATION

4.1 SAFETY RULES FOR ATTACHING TO THE TRACTOR

Road behaviour, ability to swerve and brake of the tractor also depend upon the equipment mounted.

Select a safe ground speed, in particular when travelling over rough or hilly terrain, in order to avoid upset.

The load on the front axle of the tractor depends upon the weight of the attached mower; the load on the front axle shall be at least 20 % of empty weight of the tractor.

Before attaching the machine to the three point linkage position the safety device of the tractor to avoid unintentional raising or lowering of the machine.

Before hitching check lifting and stable operation of the machine referring to the formula in paragraph 4.2.

The three point linkages of the tractor and of the machine shall correspond or be adjusted together.

Rear lifting arms could cause injury. Attach and detach the machine on level ground.

Never use remote control to raise the machine.

In the transport position secure lateral drift arms.

Position and lock the machine following the instructions in par. 4.4.

4.2 CHECK LIFTING AND STABLE OPERATION OF THE TRACTOR

For lifting and stable operation of the tractor refer to the following formula. Additional tractor front ballast may be needed.

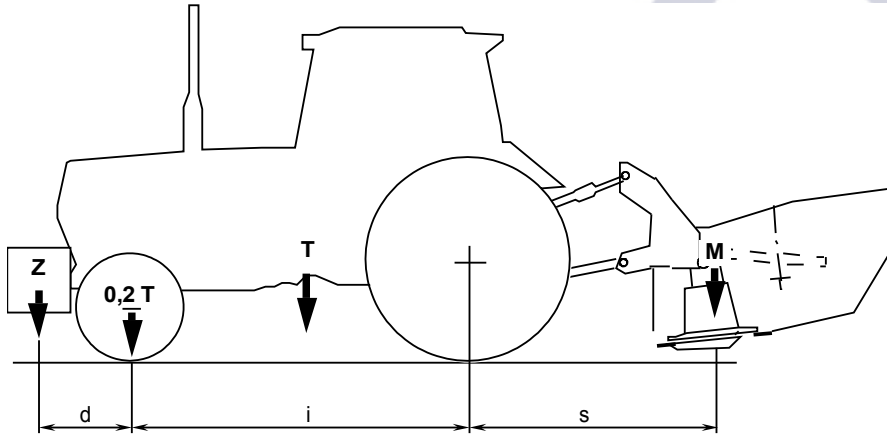

$$M \times s \leq 0,2 T \times i + Z (d + i)$$

$$M \leq 0,3 T$$

i	= Wheelbase tractor
d	= Distance between front axle and ballast
s	= Distance to the rear axle of the machine
T	= mass of the tractor + 75 kg (operator)
Z	= Mass of ballast
M	= Mass of the machine



ATTENTION!

Check lifting and stable operation of the tractor in order to avoid upset and/or loss of adherence to the road.

4.3 TRANSPORT ON PUBLIC ROADS



ATTENTION!

When driving on public roads:

Comply with the existing traffic regulations.

If tractor lights visibility is blocked by the towed machine, use detachable warning boards with lighting equipment for adequate warning to other vehicles.

Mower must be transported in the backward transport position as shown in the picture.



By this transportation system the barycentre of the machine can be significantly moved towards the tractor. The length range is considerably reduced, and the weight of the machine is shifted towards the tractor thereby facilitating transportation.

When driving on public roads, use flashing warning lights on the tractor day and night.

Should the rear overhang exceed 90% of the tractor's length, a specific authorisation for "special vehicles" may be required.

When driving on public roads, in addition to traffic regulations, follow instructions noted on the tractor licence and select a safe speed especially when transporting drawn machines or when travelling over rough or hilly terrain.

Before travelling on public roads after operation, clean debris from tyres and moving parts.

For road transport when attached to tractor (see par 4.4 and 4.4.1), heed following recommendations:

Make sure no person or animal is standing in the machine's danger area.

To raise the mower to the transport position, move the safety release bar from the three point linkage bolt **(1)** to the bolt on the machine's frame **(2)** having previously removed the shear pin **(A)**.

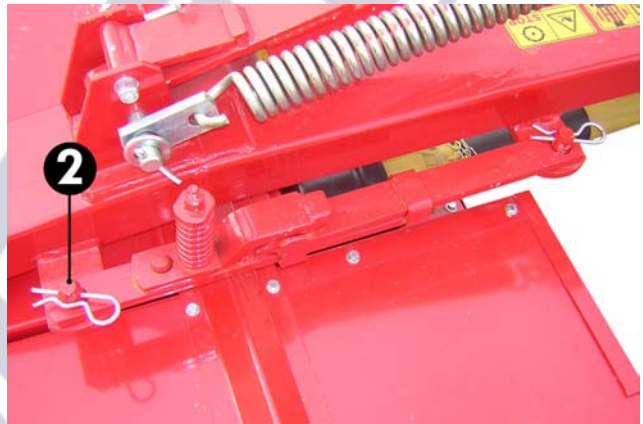
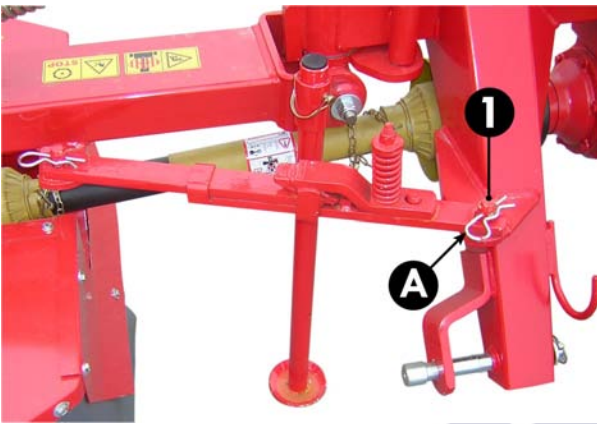

Then, pull up the three point linkage safety pin **(C)** and rotate the mower until the locking pin is inserted into the hole **(3)**.



Make sure that the safety pin is properly secured as shown in the picture. Enter the cabin and use the hydraulic control to raise the mower.

**ATTENTION!**

During transport with raised mower make sure that the control lever is properly secured to avoid unintentional lowering of the machine.

Machines equipped with hydraulic control: after connecting the hydraulic couplings (see par. 4.4.2) release the three point linkage safety pin (**A**), then raise the mower and move it backwards using the hydraulic control. Activate the hydraulic locking device using the tap on the hydraulic hose.

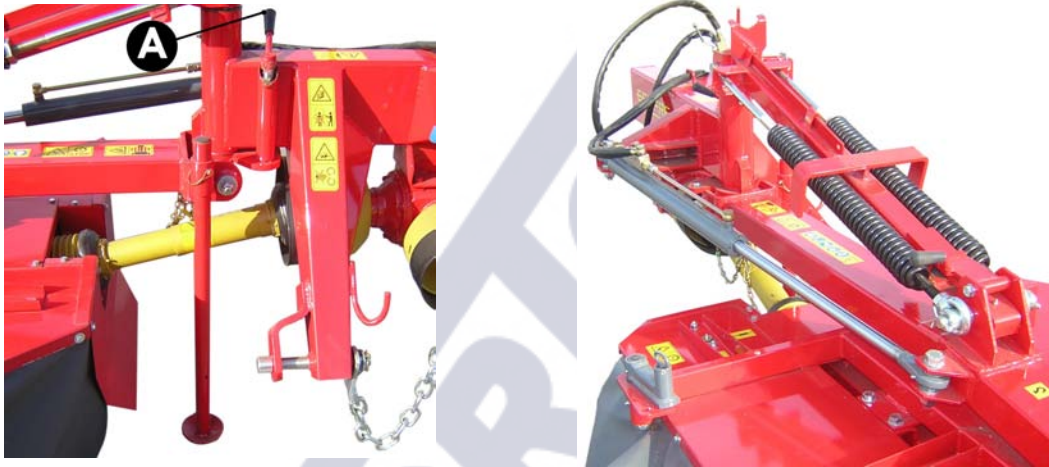

All models: before transport, engage the locking lever (**C**) and fasten lever (**D**) to prevent the machine from swaying during transport.

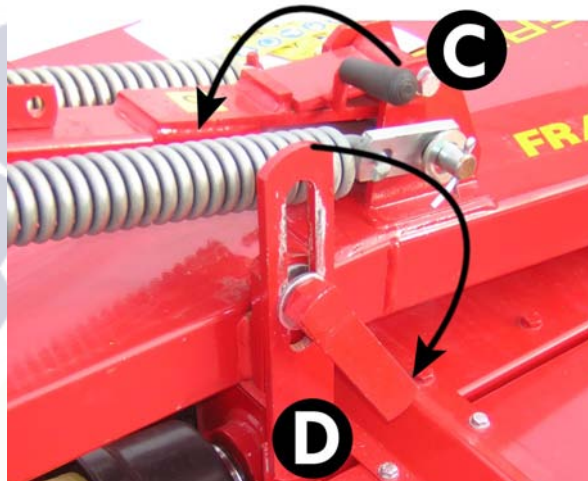

4.4 ATTACHING TO THE THREE POINT LINKAGE OF THE MACHINE

All GALFRÈ snc MOWERS can be attached to any kind of tractor equipped with universal three point linkage.

The area shall be properly lightened under conditions of reduced visibility. Nobody shall be within 5 metres of hitching point.

Approach the tractor to the mower until the lifting bars and the three point linkage of the machine are lined up and connect them with the pins.



ATTENTION!

Insert and secure shear pins. Make sure that shear pins are locked properly.

Connect the three point to the upper hitch link and adjust length so that the mower is parallel to the ground. Before attaching or detaching the mower make sure that the control lever is properly positioned as to avoid unintentional raising or lowering of the mower.



ATTENTION!

Insert and secure shear pins. Lock the safety device to avoid loosening of the three point.



Three-point linkage

Conditioner-equipped models are provided with a chain that can be positioned in the third point area of the tractor (**A**) in order to maintain the mower at the same height from the ground when lowering the lift.

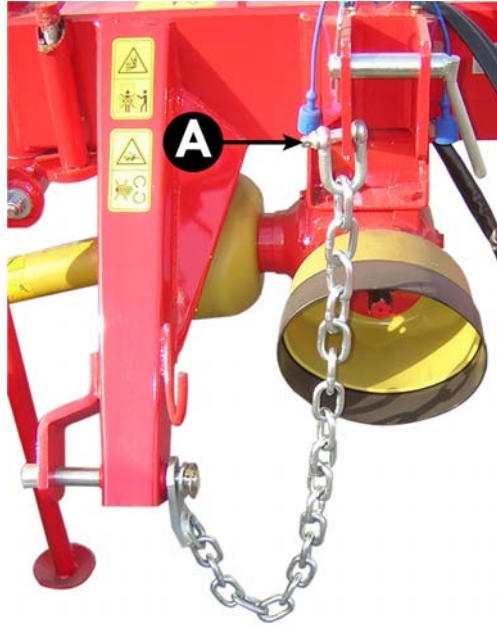

Raise the stand and secure it using the pin. Stand shall always be attached to the machine.



Stand

Slightly raise the machine and use lateral lifting arms to keep the machine level.

4.4.1 ASSEMBLY OF THE DRIVE SHAFT

After attaching the machine to the tractor, connect the drive shaft to the power takeoff of the tractor (before performing this operation stop engine and remove the key).

Before using the drive shaft read the use and maintenance manual of the drive shaft.

If you use a different drive shaft type than the one supplied with the machine, make sure that the covers of the machine and the tractors overlap by at least 5 cm in compliance with existing law.

- Clean and lubricate the power takeoff.
- Lubricate on a regular basis the drive shaft following the instructions given by the manufacturer of the drive shaft (see Use and Maintenance Manual of the drive shaft).
- Follow assembly instructions given by the manufacturer and direction indicated on the external side of the guard (drawing of the tractor on the external pipe of the shaft towards the power takeoff of the tractor).
- Hang chains to avoid rotation.
- Make sure that the safety locking device (pushbutton or ring-nut) is properly installed and secured.



WARNING!

Check the direction of rotation and make sure that the power takeoff speed is 540 r.p.m., because the machine has been designed for this speed.



ATTENTION!

Connect the drive shaft last to the power takeoff and detach it first after operation.

Use exclusively **drive shafts with EC mark** to ensure proper operation of the machine.

Use only drive shafts with all safety guards in good conditions.

The length of the drive shaft shall be adapted to the tractor.

WHENEVER the drive shaft is disengaged from the power takeoff of the tractor place it on its support leg.

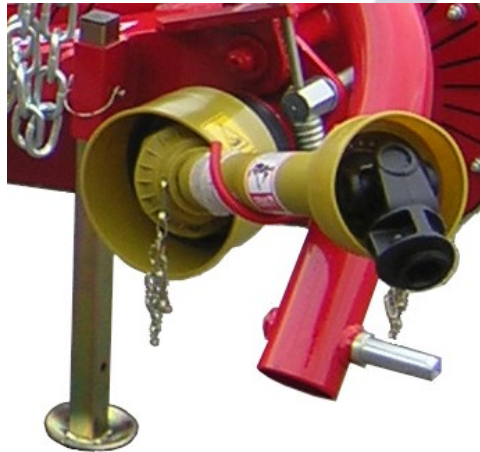

Support leg of the drive shaft

GALFRÈ snc is not liable for any damages resulting from misuse and improper assembly of the drive shaft.

In addition to the drive shaft – which is provided with a clutch to avoid damage to the machine in case of collision with obstacles - drum mowers are equipped with an overrunning clutch drive shaft.



Overrunning clutch drive shaft

4.4.2 HYDRAULIC SYSTEM

Before connecting the hydraulic couplings (quick couplings) to the distributors of the tractor stop engine and operate the distributors levels in both directions in order to make sure that the circuits of the tractor and the machine are not under pressure.

Check hydraulic hoses for wear and scratches after every operation and replace them with new ones provided by the Manufacturer if necessary.

If there is a leak stop the engine of the tractor, disengage power takeoff, relieve pressure in the hydraulic system, disconnect hydraulic hoses using safety gloves (make sure you have a bin to collect used oil) and replace them with new ones supplied by the Manufacturer. Used oil is harmful according to the existing law, therefore it shall be collected properly.

Fluids under pressure such as oil in an hydraulic system can cause severe injury and infections. Seek medical assistance if necessary.

Make sure that all couplings are clean and in good conditions before connecting the quick hydraulic hoses to the tractor.

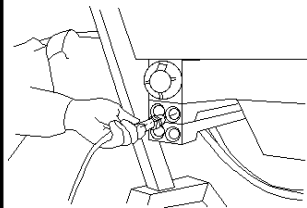

Make sure that all hydraulic hoses are properly connected according to colour code. Reversing connections may cause reverse tool operation which can cause severe personal injury.

Check wear on hydraulic hoses and replace them if necessary (anyway at least every 6 years).



ATTENTION!

**The hydraulic cylinder is supplied without oil.
Fill the hydraulic system and drive at least twice to the right and to the left respectively to check proper connection of the system.**

After mowing place hydraulic hoses in their brackets.



4.5 ADJUSTEMENTS

Before operating the machine make the necessary adjustments.

Correct adjustment of the machine ensures proper operation of the machine, and helps improve performance and reduce knives wear.

- In order to reduce the load of the machine on the ground and for the machine to be parallel to the ground adjust spring tension using their corresponding bolts **(A)** as shown in the picture.

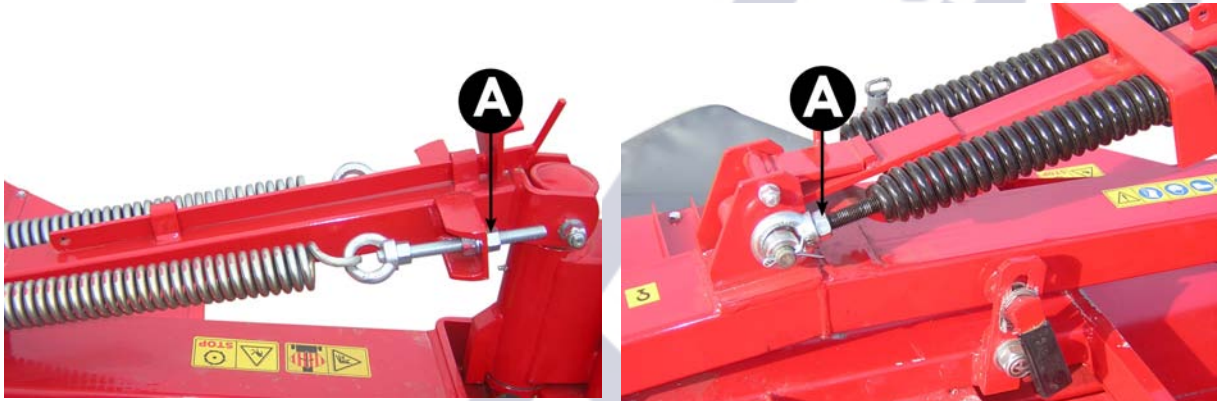

Mod. FR/G 170 – FR/G 190

Mod. FR/G 210

- To change windrow form and width (only mod. FR/G 210) adjust the rear wings bolt **(A)** in one of the four different positions.



Mod. FR/G 210

- Adjustment of cutting height is achieved in two ways.

The first one is achieved by altering the forward tilting angle of the mower. In order to tilt the mower bar forward use the tractor three point linkage.

The second one is achieved by changing type of knives (A and B) or by inserting distance plates between the knives holder and the supporting plate (C).

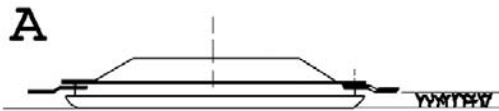

A – Lower cutting height with curved knife

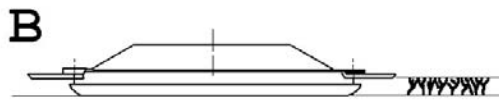

B – Regular cutting height with straight knife

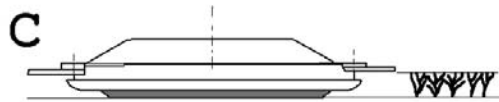

C – Higher cutting height with distance plate

For knife replacement, see par. 6.3.

In general quality of mowing and power requirement depend upon:

- Kind of product to be mowed;
- Type of knives used;
- Working height;
- Speed of the tractor;

Altering the distance between the conditioning rollers allows to adjust the conditioning intensity. To do so, use adjustment nuts (**A**) set on the sides, as shown in the picture.



5 OPERATING INSTRUCTIONS



ATTENTION!

Before operation check the oil level in the gearbox and if necessary add some oil (for this operation follow instructions contained in par. 6.2).



Wear suitable Protective Devices (safety shoes, safety gloves, ear plug, dust mask and safety glasses)



ATTENTION!

During operation make sure that no people or animals are within 50 meters of the machine.

If anyone approaches, stop working and shut off the engine.



ATTENTION!

The curtain shall be in place around the cutter bar to prevent the hazard of thrown objects. Check wear and scratches on the curtain.

Make sure that knives can rotate freely.

GALFRÈ recommends to use tractors with cabin and to mount a protective grid behind the driver's seat to protect operator against thrown objects.

Once on the field:

- make sure that the safety release bar is linked to the three point linkage bolt **(1)** and secured by the safety pin **(1)**.

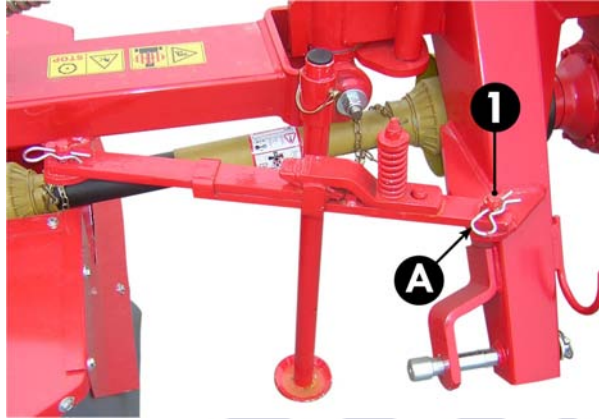

- Make sure that the safety pin is properly secured as shown in the picture.

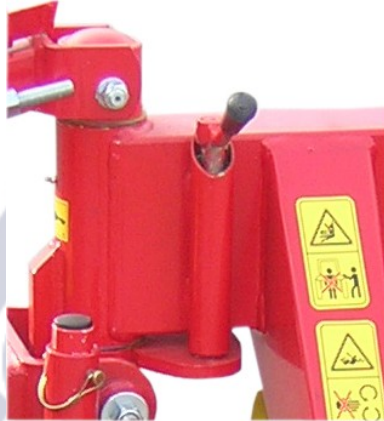

Release the locking lever **(B)** and unfasten lever **(C)** so that the machine can pivot during work.

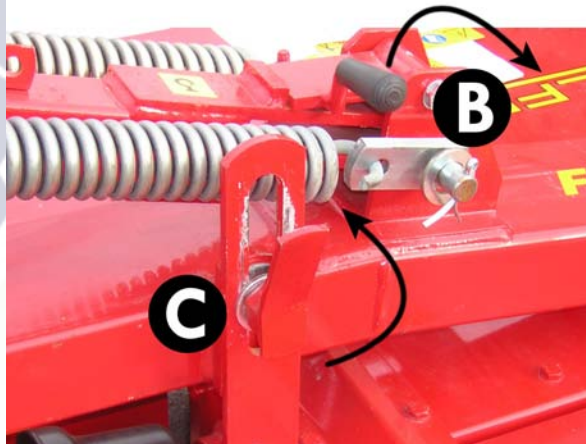

Lower the mowing unit with the aid of the distributor located on the tractor.

**ATTENTION!**

Before dismounting from the tractor to make any adjustment stop the engine of the tractor, disengage power takeoff, set hand brake and remove the ignition key.

Position the "power takeoff" level to 540 r.p.m.

Increase engine speed to run the tractor at 1000 ÷ 1300 r.p.m. and reach 250 ÷ 300 r.p.m. power takeoff.

Drive a short distance and check mowing, review adjustments if necessary.

It is recommended to select a speed between 10 and 15 km/h. Anyway, speed shall depend upon the kind of terrain.

During working avoid turns with the machine lowered to the ground and do not drive the tractor in the reverse motion.

Before changing direction and turning raise the mower and disengage power takeoff.

Hard working conditions, for instance rough terrain, require a slower speed.

5.1 SAFETY RELEASE DEVICE

If an obstacle is hit the safety release device allows the cutter bar to swing back, thus providing shock absorption.

Stop engine and disengage power takeoff of the tractor. Before reinstalling the safety device reverse the car for 2 metres.

Before resuming operation check adjustment of the safety release device and make sure that cutter components have not been damaged.

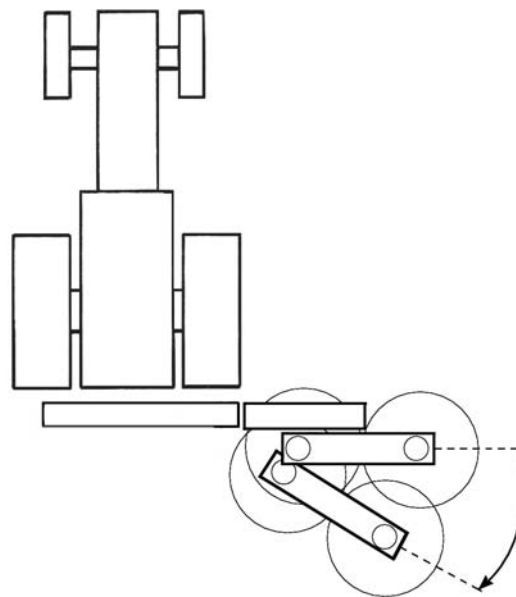

Safety release device

6 MAINTENANCE

This section contains recommendations for regular maintenance of the machine, basing on company experience as well as suggestions by our customers.

These recommendations can be further integrated by contributions from our customers, for which we thank you very much in advance.

Careful and systematic servicing helps reduce maintenance costs and ensure efficient operation.



ATTENTION!

Before maintenance, adjustment and cleaning lower the machine to the ground, turn off the engine of the tractor, disengage power takeoff, set hand brake, remove the ignition key.

If there is any trouble the operator shall stop the machine, identify the trouble and make repairs if necessary.

If you use compressed air or water for cleaning the machine, wear suitable safety glasses or masks and keep people and animals away. Do not use any inflammable fluids.

During maintenance wear the suitable Protective Devices (safety shoes and gloves) and follow all relevant safety precautions.

It is recommended to check tightness of all nuts and bolts, including those of the knives, **every 8 hours of work.**

6.1 LUBRICATION OF MECHANICAL COMPONENTS

Before operation and every 8 hours of work, lubricate all bearings, pins and the telescopic rod of the cardan joint using quality grease.

When the mower is not used for a longer period, clean and grease the drive shaft.

In winter and when temperature is very low grease pipes to protect plastics.

Clean debris from the lubricators heads before injecting lubricating grease.

Grease following point with lithium grease.

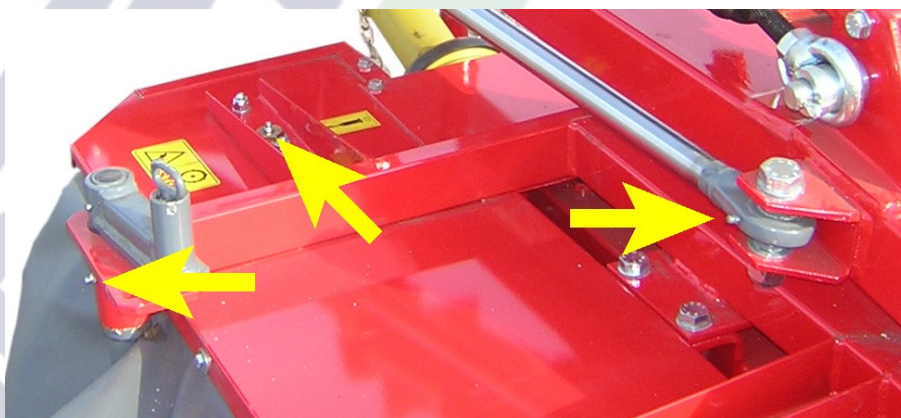
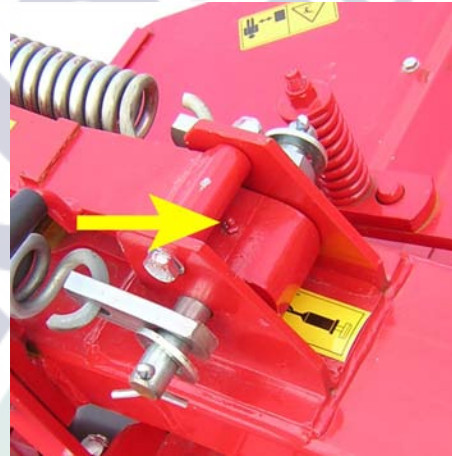

6.2 LUBRICATION



ATTENTION!

Before performing an inspection, stop the engine of the tractor, remove the ignition key and disengage cardan-shaft transmission.

Collect used oil and bring it to the Oil Collection Centre. Do not pollute the environment. (in Italy, C.O.O.U. – Consorzio Obbligatorio Oli Usati – Free number 800 863 048).

6.2.1 LUBRICATION OF THE CENTRE GEARBOX

In order to check oil level, stop the machine and make sure it is set in horizontal position.



Use **SAE 90 EP** oil. Oil tank capacity is around 5 L in mod. FR/G 170, FR/G 190 and FR/G 210 and around 3 L in mod. FR/G 130.

Change oil in the unit **after the first 10/15 hours of work**.

Then replace oil **every 500 hours of work** and at least once a year. When the mower is used for a long period, check oil level on a daily basis and add oil if necessary.

Use the dipstick on the filler cap to check oil level.



Oil tank

6.2.2 LUBRICATION OF OVERGEAR UNIT

Use oil type **SAE 90 EP**. Tank capacity is around 1 L in mod FR/G 170, FR/G 190 and FR/G 210, and around 0,5 L in mod FR/G 130.

Change the oil in the overgear unit **after the first 10/15 hours of work**. Then replace oil **every 500 hours of work** and at least once a year.



Gearbox

6.2.3 LUBRICATION OF CONDITIONER REDUCTION GEARBOX

Use oil type **SAE 90 EP**. Tank capacity (**A** and **B**) is around 0,5 L each.

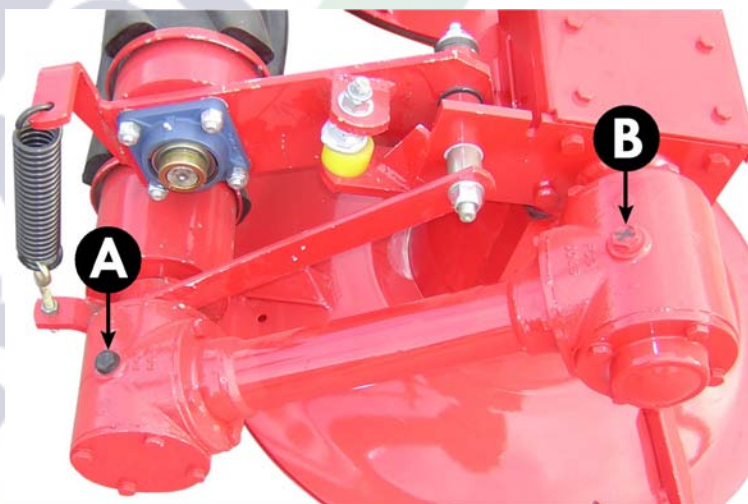

Reduction gearbox

6.3 KNIVES

Working on rough terrain may cause damages to knives (deformation and scratches) and therefore lower cutting quality while increasing the risk of accidents and wear.



ATTENTION!

Damaged knives can more easily be thrown away from the machine and cause serious injury to the operator and other people even at a relevant distance.

Fasteners of knives shall be checked regularly.

Make a careful inspection after an obstacle is hit, or knives have been replaced and at the beginning and at the end of the season.



Drums have been previously equilibrated electronically: it is recommended to replace all tools at once.

Replace worn or deformed discs. Never replace one knife only. When one knife is worn, replace all of them.

Knives provided with conditioner-equipped machines bear an arrow to indicate knife rotation direction.

Use exclusively knives in conformity with ISO 5718.

Knives replacement is quick and easy. Use the special pry bar to open the knife holder and remove knives: make sure the knife is properly seated on the spindle.

Never replace one knife only. When one knife is worn, replace all of them.



6.4 CURTAIN REPLACEMENT

Before any operation check wear on the curtain and on the attaching devices. Replace worn curtain.

Use exclusively curtains supplied by GALFRÈ.

Mod. FR/G 170 – FR/G 190 – FR/G 210

In order to remove the damaged curtain, loosen the clamping screws on all sides, as shown in the picture.

Place the curtain on the borders of the cutter unit and secure it with screws, washers and nuts.



Mod. FR/G 130

In order to remove the damaged curtain, loosen the belts connected to the frame of the cutter unit



Fold back the curtain and secure it with belts.

6.5 FURTHER TROUBLESHOOTING

In the event of excessive vibrations check wear on the knives and the cutter-holder discs, check tightness of all bolts and nuts, check lubrication of the gearbox and of the reduction gearbox in case of models with conditioner.

Excessive vibration can lead to prolonged noise exposure and affect performance, since mechanical parts are subject to more stress.

In the event of prolonged vibration contact the service department of GALFRÈ or its dealer.

TRACTORTOOLS
DIRECT

7 GUARANTEE

GALFRÈ warrants that GALFRÈ products will be free from defects in material and workmanship for a period of **one year** beginning on the date of delivery to end user indicated in the **Delivery and Guarantee Certificate**.

The Delivery Certificate shall be sent by the dealer namely the buyer within 30 (thirty) days from delivery date, if not the guarantee will be void.

GUARANTEE CONDITIONS

- 1) The guarantee is limited to the replacement or repair of any part recognised as being defective in material and workmanship by our technical service.
- 2) The components of the machine not manufactured by Galfrè (es. curtain, knives, belts, drive shafts, hydraulic cylinders and spring tines) are not covered by Galfrè guarantee, but by the guarantee of the respective manufacturers.
- 3) The guarantee does not apply to any part which has been altered or disassembled by unauthorised persons or which has been used for a purpose for which the product is not designed.
- 4) The guarantee does not apply to any part which has been misused or damaged by accident or negligence.
- 5) Labour cost and transport for repairing or replacing defective parts are not covered by the guarantee.
- 6) No guarantee other than the guarantee issued by the manufacturer will be valid;
- 7) The manufacturer reserves the right to make changes to the machines in production without notice and without incurring any obligation to apply these modifications to machines previously sold or on sale.
- 8) At delivery make sure that the machine has not been damaged during transport and that it is complete with all parts, further claims shall be submitted in writing within 8 days from delivery date of the machine.

The guarantee shall not apply:

- 1) If the defect is due to driving failure.
- 2) If the damaged part has been repaired by unauthorised persons or if not originally manufactures spare parts have been used.
- 3) The guarantee is strictly subject to compliance with the following rules both by the dealer and the user or buyer:
 - a) The guarantee document shall be returned within one month from the date of occurrence of the damage. Fill in the form on the document and make sure you provide following information:
 - 1) Name and address of the dealer and the buyer.
 - 2) Machine type and model.
 - 3) Serial number and year of manufacture.
 - 4) Date of delivery to the buyer.
 - 5) Date of damage occurrence.
 - 6) Number of hours or hectares of use of the machine.
 - 7) Power of the tractor used.
 - 8) Detailed description of the presumed cause for the damage.
 - 9) Quantity and description of defective parts (use reference numbers in the spare parts catalogue).

Defective parts shall be returned to Galfrè.

The related freight costs are at the charge of the sender.

The guarantee shall not be transferred to a person other than the final buyer without written agreement by Galfrè.

Galfrè has the exclusive right to acknowledge a part under guarantee as being defective. The decision to either accept or reject the guarantee is binding and irrevocable and the buyer undertakes to accept it.

In the event that the guarantee claim is not accepted the dealer shall request the return of the damaged parts within fifteen days from the date of receipt of the confirming letter from Galfrè. After this period defective parts will be destroyed.

Galfrè dealers do not have under any circumstances the right to make any decisions in the name of Galfrè.

No other guarantee of any kind whatsoever and all liabilities, legal or conventional, expressed or implied, exceeding the obligations set forth in this written warranty are hereby disclaimed and excluded from this sale.

Galfrè liability shall not under any circumstance exceed those described in the above paragraphs.

8 SPARE PARTS

For replacing parts of the ROTARY DISC MOWER the customer shall use exclusively originally manufactured spare parts. Spare parts shall be ordered from GALFRÈ snc or from its authorised dealer.

When ordering spare parts provide specifications indicated on the identification plate, in particular:

- serial number
- model
- year of the production
- frame number

GALFRÈ snc guarantees spare parts for a period of minimum **5 years from the end of the production of a model.**